



**HOSO**  
Technology

コンクリート圧送配管 カタログ  
ホーソー・テクノロジー株式会社

▶ ST52 Pipe



Part No.	Name	Specification	W.P.
MST4453	ST52 Pipe	DN100 × 4.5mm × 3m × SK 100 4-1/2 *	85bar
MST5453	ST52 Pipe	DN125 × 4.5mm × 3m × SK 125 5-1/2 *	85bar
MST5503	ST52 Pipe	DN125 × 5.0mm × 3m × SK 125 5-1/2 *	85bar
MST5603	ST52 Pipe	DN125 × 6.0mm × 3m × SK 125 5-1/2 * Insert hardened liner	85bar
MST5703	ST52 Pipe	DN125 × 7.0mm × 3m × SK 125 5-1/2 * Insert hardened liner	85bar
MST5803	ST52 Pipe	DN125 × 8.0mm × 3m × SK 125 5-1/2 * Insert hardened liner	85bar

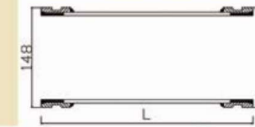

▶ Schwing M/F Pipe



Part No.	Name	Specification	W.P.
MMF5453	MF Pipe	DN125 × 4.5mm × 3m × MF 125 5 *	130bar
MMF5503	MF Pipe	DN125 × 5.0mm × 3m × MF 125 5 *	130bar
MMF5603	MF Pipe	DN125 × 6.0mm × 3m × MF 125 5 *	130bar
MMF5703	MF Pipe	DN125 × 7.0mm × 3m × MF 125 5 *	130bar
MMF5803	MF Pipe	DN125 × 8.0mm × 3m × MF125 5 *	200bar

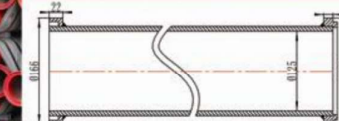

▶ Putzmeister ZX Pipe



Part No.	Name	Specification	W.P.
MZX5403	ZX Pipe	DN125 × 4.5mm × 3m × ZX 125 5 *	130bar
MZX5503	ZX Pipe	DN125 × 5.0mm × 3m × ZX 125 5 *	130bar
MZX5603	ZX Pipe	DN125 × 6.0mm × 3m × ZX 125 5 *	130bar
MZX5703	ZX Pipe	DN125 × 7.0mm × 3m × ZX 125 5 *	130bar
MZX5803	ZX Pipe	DN125 × 8.0mm × 3m × ZX 125 5 *	200bar

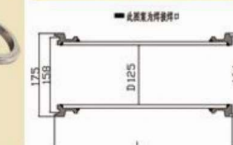

# コンクリート圧送配管 カタログ

## Hardened Pipe

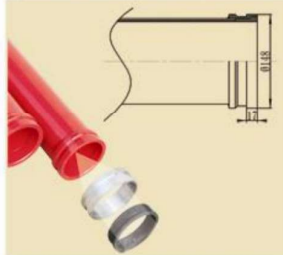

Part No.	Name	Description	W.P.
MHP5453	Hardened Pipe	DN125 x 4.5mm x 3m x SK 125 5-1/2" Twin	85bar
MHP5483	Hardened Pipe	DN125 x 4.8mm x 3m x SK 125 5-1/2" Twin	85bar
MHP5503	Hardened Pipe	DN125 x 5.0mm x 3m x SK 125 5-1/2" Twin	85bar
MHP5703	Hardened pipe	DN125 x 7.0mm x 3m x SK 125 5-1/2" Twin	85bar

## Twin Wall Pipe

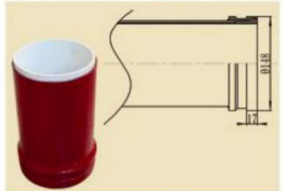

Part No.	Name	Description	W.P.
MTWP5453	Twin Wall Pipe	DN125 x (2.5+2)mm x 3m x SK 125 5-1/2" Twin	85bar
MTWP5503	Twin Wall Pipe	DN125 x (3+2)mm x 3m x SK 125 5-1/2" Twin	85bar
MTWP5703	Twin Wall Pipe	DN125 x (5+2)mm x 3m x SK 125 5-1/2" Twin	85bar

## Reducer Pipe



Part No.	Name	Description
MTWR60501	Twin Wall Reducer	6" - 5" x 1600mm
MTWR60502	Twin Wall Reducer	6" - 5" x 1500mm
MTWR60503	Twin Wall Reducer	6" - 5" x 1400mm
MTWR60504	Twin Wall Reducer	6" - 5" x 1200mm
MTWR60505	Twin Wall Reducer	6" - 5" x 500mm
MR70601	Reducer	7" - 6" x 1300mm
MR70602	Reducer	7" - 6" x 1100mm
MR70603	Reducer	7" - 6" x 830mm
MR70604	Reducer	7" - 6" x 500mm
MR70501	Reducer	7" - 5" x 1200mm
MR60501	Reducer	6" - 5" x 3000mm
MR60502	Reducer	6" - 5" x 1800mm
MR60503	Reducer	6" - 5" x 1600mm
MR60504	Reducer	6" - 5" x 1500mm
MR60505	Reducer	6" - 5" x 1400mm
MR60506	Reducer	6" - 5" x 1200mm
MR60507	Reducer	6" - 5" x 1100mm
MR60509	Reducer	6" - 5" x 1000mm

## Reducer Pipe



Part No.	Name	Description
MR605010	Reducer	6" - 5" x 500mm
MR50401	Reducer	5" - 4" x 1950mm
MR50402	Reducer	5" - 4" x 918mm
MR50403	Reducer	5" - 4" x 620mm
MR40201	Reducer	4" - 2" x 1200mm
MR50301	Reducer	5" - 3" x 1000mm
MR40301	Reducer	4" - 3" x 1200mm
MR40302	Reducer	4" - 3" x 918mm
MR40303	Reducer	4" - 3" x 600mm
MR50401	Reducer	5" - 4" x 1950mm

## Twin Wall Elbow



Part No.	Name	Description
MTWE90	Twin Wall Elbow	DN125 x R275 x 90° SK-SK
MTWE45	Twin Wall Elbow	DN125 x R275 x 45° SK-SK
MTWE30	Twin Wall Elbow	DN125 x R275 x 30° SK-SK
MTWE20	Twin Wall Elbow	DN125 x R275 x 20° SK-SK
MTWE15	Twin Wall Elbow	DN125 x R275 x 15° SK-SK
MTWE10	Twin Wall Elbow	DN125 x R275 x 10° SK-SK
MPM90-2	Twin Wall Elbow	PM 6" - 6" x 90° ZX 150 6"

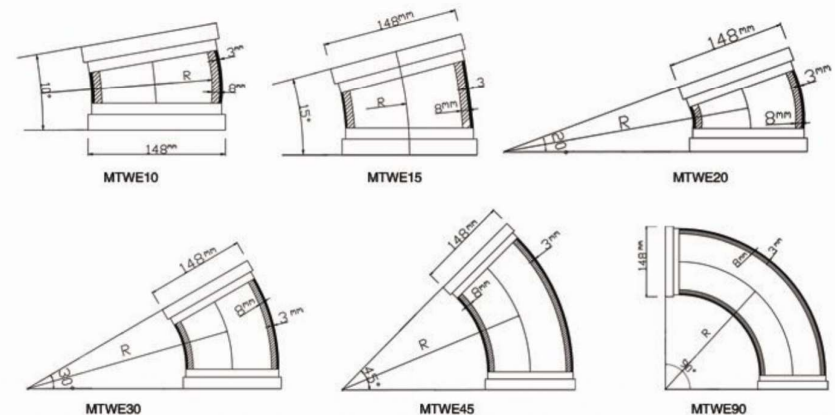

# コンクリート圧送配管 カタログ

## ▶ Pipe Bend

Part No.	Name	Description
MBSK4-500-45	Bend	DN100 × 45D × R500 SK 100 4-1/2 "
MBSK4-500-90	Bend	DN100 × 90D × R500 SK 100 4-1/2 "
MBSK4-1000-45	Bend	DN100 × 45D × R1000 SK 100 4-1/2 "
MBSK4-1000-90	Bend	DN100 × 90D × R1000 SK 100 4-1/2 "
MBSK5-500-15	Bend	DN125 × 15D × R500 SK125 5-1/2 "
MBSK5-500-30	Bend	DN125 × 30D × R500 SK125 5-1/2 "
MBSK5-500-45	Bend	DN125 × 45D × R500 5-1/2 "
MBSK5-500-60	Bend	DN125 × 60D × R500 SK125 5-1/2 "
MBSK5-500-90	Bend	DN125 × 90D × R500 SK125 5-1/2 "
MBSK5-1000-15	Bend	DN125 × 15D × R1000 SK125 5-1/2 "
MBSK5-1000-30	Bend	DN125 × 30D × R1000 SK125 5-1/2 "
MBSK5-1000-45	Bend	DN125 × 45D × R1000 SK125 5-1/2 "
MBSK5-1000-60	Bend	DN125 × 60D × R1000 SK125 5-1/2 "
MBSK-1000-90	Bend	DN125 × 90D × R1000 SK125 5-1/2 "
MBMF15	Bend	DN125 × 15D × R1000 MF 125 5 "
MBMF30	Bend	DN125 × 30D × R1000 MF 125 5 "
MBMF45	Bend	DN125 × 45D × R1000 MF 125 5 "
MBMF60	Bend	DN125 × 60D × R1000 MF 125 5 "
MBMF90	Bend	DN125 × 90D × R1000 MF 125 5 "
MBZX15	Bend	DN125 × 15D × R1000 ZX 125 5 "
MBZX30	Bend	DN125 × 30D × R1000 ZX 125 5 "
MBZX45	Bend	DN125 × 45D × R1000 ZX 125 5 "
MBZX60	Bend	DN125 × 60D × R1000 ZX 125 5 "
MBZX90	Bend	DN125 × 90D × R1000 ZX 125 5 "

## ▶ Cast Elbow

Part No.	Name	Description
PCE18090	Cast Elbow	DN125 × R180 × 90°
PCE22590	Cast Elbow	DN125 × R225 × 90°
PCE26090	Cast Elbow	DN125 × R260 × 90°
PCE26090-1	Cast Elbow	DN125 × R260 × 90° +211
PCE27590	Cast Elbow	DN125 × R275 × 90°
PCE34090	Cast Elbow	DN125 × R340 × 90°
PCE27545	Cast Elbow	DN125 × R275 × 45°
PCE27545-1	Cast Elbow	DN125 × R275 × 45° +170
PCE27545-2	Cast Elbow	DN125 × R275 × 45° +411
PCE31530	Cast Elbow	DN125 × R315 × 30°
PCE27530	Cast Elbow	DN125 × R275 × 30°
PCE24030	Cast Elbow	DN125 × R240 × 30°
PCE38529	Cast Elbow	DN125 × R385 × 29°
PCE27515	Cast Elbow	DN125 × R275 × 15°
PCE24015	Cast Elbow	DN125 × R240 × 15°

## ▶ Clamp

Part No.	Name	Description
PTWBC2	Bolt Clamp	2 " forging and casting
PTWBC3	Bolt Clamp	3 " forging and casting
PTWBC4	Bolt Clamp	4 " forging and casting
PTWBC5	Bolt Clamp	5 " forging and casting
PTWBC6	Bolt Clamp	6 " forging and casting
PTWBCB5	Bolt clamp with Bracket	5 " forging and casting
PTW2BC5	Two Bolt Clamp	5 " forging and casting
PTWSC2	Snap Clamp	2 " forging and casting
PTWSC3	Snap Clamp	3 " forging and casting
PTWSC4	Snap Clamp	4 " forging and casting
PTWSC45	Snap Clamp	4.5 " forging and casting
PTWSC5	Snap Clamp	5 " forging and casting
PTWSC6	Snap Clamp	6 " forging and casting
PTWHD2	HD NON ADJ Clamp	2 " casting
PTWHD2.5	HD NON ADJ Clamp	2.5 " casting
PTWHD3	HD NON ADJ Clamp	3 " casting
PTWHD4	HD NON ADJ Clamp	4 " casting
PTWHD5	HD NON ADJ Clamp	5 " casting
PTWHD A3	HD ADJ Clamp	3 " casting
PTWHD A4	HD ADJ Clamp	4 " casting
PTWHD A5	HD ADJ Clamp	5 " casting
PTWHD2B5	HD 2-B Clamp	5 " casting

## ▶ Weld-on Collar

Part No.	Name	Description
PSK100-1	SK collar	DN100 4 "
PSK100-2	SK collar	DN100 4-1/2 "
PSK125	SK collar	DN125 5-1/2 "
PSK150-1	SK collar	DN150 6 "
PSK150-2	SK collar	DN150 6-1/2 "

Part No.	Name	Description
PHD15	HD collar	1.5 " HD
PHD20	HD collar	2 " HD
PHD25	HD collar	2.5 " HD
PHD30	HD collar	3 " HD
PHD40	HD collar	4 " HD
PHD50	HD collar	5 " HD

# コンクリート圧送配管 カタログ

## ▶ Weld-on Collar

### ▷ Single -Side Collar



Part No.	Name	Description
PC50	Collar	DN50 2 "
PC75	Collar	DN75 3 "
PC80	Collar	DN80 3-1/4 "
PC100-1	Collar	DN100 4 "
PC100-2	Collar	DN100 4-1/2 "
PC100-3	Collar	DN100 4-1/2 " 122mm
PC125-1	Collar	DN125 5 "
PC125-2	Collar	DN125 5-1/2 "
PC150-1	Collar	DN150 6 "
PC150-2	Collar	DN150 6-1/2 "
PC175	Collar	DN175 7 "
PC200	Collar	DN200 8 "

### ▷ GR Collar



Part No.	Name	Description
PGC50	GR collar	DN50 2 " ( OD60mm )
PGC65	GR collar	DN65 2.5 " ( OD66.5mm )

### ▷ ZX Collar



Part No.	Name	Description
PZX125	ZX Collar with lip	ZX 125 5 "
PZX150	ZX Collar with lip	ZX 150 6 "

### ▷ M/F Collar



Part No.	Name	Description
PMF125-1	MF Collar	MF 125 5 "
PMF125-2	MF Collar with lips	MF 125 5 "
PMF150	MF Collar	MF 150 6 "

### ▷ Twin Collar



Part No.	Name	Description
PTC125-1	Twin Collar	DN125 5-1/2 "
PTC125-2	Twin Collar	DN125 5-1/2 "

## ▶ Rubber Hose

### ▷ Fabric Braid Hose



Part No.	Name	Description
PFBH001	Fabric Braid Hose	DN125 5 " × 3M, two ends
PFBH002	Fabric Braid Hose	DN125 5 " × 3M, one end
PFBH003	Fabric Braid Hose	DN125 5 " × 4M, two ends
PFBH004	Fabric Braid Hose	DN125 5 " × 4M, one end
PFBH005	Fabric Braid Hose	DN125 5 " × 6M, two ends
PFBH006	Fabric Braid Hose	DN125 5 " × 6M, one end
PFBH007	Fabric Braid Hose	4.5 " × 3M
PFBH008	Fabric Braid Hose	4.5 " × 4M
PFBH009	Fabric Braid Hose	4 " × 3M
PFBH010	Fabric Braid Hose	4 " × 4M
PFBH011	Fabric Braid Hose	3.5 "
PFBH012	Fabric Braid Hose	3 "
PFBH013	Fabric Braid Hose	2.5 "
PFBH014	Fabric Braid Hose	2 "
PFBH015	Fabric Braid Hose	1.5 "
PFBH016	Fabric Braid Hose	1.25 "

### ▷ Steel Wire Braide Hose



Part No.	Name	Description
PWBH001	Wire Braid Hose	DN125 5 " × 3M, two ends, 4-ply wire
PWBH002	Wire Braid Hose	DN125 5 " × 3M, one end, 4-ply wire
PWBH003	Wire Braid Hose	DN125 5 " × 4M, two ends, 4-ply wire
PWBH004	Wire Braid Hose	DN125 5 " × 4M, one end, 4-ply wire
PWBH005	Wire Braid Hose	DN125 5 " × 6M, two ends, 4-ply wire
PWBH006	Wire Braid Hose	DN125 5 " × 6M, one end, 4-ply wire
PWBH007	Wire Braid Hose	DN125 5 " × 3M, two ends, 2-ply wire
PWBH008	Wire Braid Hose	DN125 5 " × 3M, one end, 2-ply wire
PWBH009	Wire Braid Hose	DN125 5 " × 4M, two ends, 2-ply wire
PWBH010	Wire Braid Hose	DN125 5 " × 4M, one end, 2-ply wire
PWBH011	Wire Braid Hose	DN125 5 " × 6M, two ends, 2-ply wire
PWBH012	Wire Braid Hose	DN125 5 " × 6M, one end, 2-ply wire
PWBH013	Wire Braid Hose	4 "
PWBH014	Wire Braid Hose	3.5 "
PWBH015	Wire Braid Hose	3 "
PWBH016	Wire Braid Hose	2.5 "
PWBH017	Wire Braid Hose	2 "

# コンクリート圧送配管 カタログ

## ▶ Cleaning Ball



Part No.	Name	Description
PCB201	Cleaning ball	2" soft
PCB202	Cleaning ball	2" medium
PCB203	Cleaning ball	2" hard
PCB301	Cleaning ball	3" soft
PCB302	Cleaning ball	3" medium
PCB303	Cleaning ball	3" hard
PCB401	Cleaning ball	4" soft
PCB402	Cleaning ball	4" medium
PCB403	Cleaning ball	4" hard
PCB501	Cleaning ball	5" soft
PCB502	Cleaning ball	5" medium
PCB503	Cleaning ball	5" hard
PCB601	Cleaning ball	6" soft
PCB602	Cleaning ball	6" medium
PCB603	Cleaning ball	6" hard

## ▶ Gasket



Part No.	Name	Description
PG50	gasket	DN50 2"
PG75	gasket	DN75 3"
PG100-1	gasket	DN100 4" (124mm)
PG100-2	gasket	DN100 4" (122mm)
PG125-1	gasket	DN125 5"
PG125-2	gasket	DN125 5" with short lips
PG125-3	gasket	DN125 5" HD
PG125-4	gasket	DN125 5" PU gasket
PG150-1	gasket	DN150 6"
PG150-2	gasket	DN150 6" PU gasket
PG175	gasket	DN175 7"
PG200	gasket	DN200 8"

## ▶ Manual Shut-off Valve



Part No.	Name	Description
PPSOV45	Manual shut-off valve	DN100 4-1/2"
PPSOV55	Manual shut-off valve	DN125 5-1/2"

## ▶ Concrete Pump Piston

### ▷ Schwing Piston



Part No.	Name	Description
PSCHP001	Schwing piston Ram	φ250
PSCHP002	Schwing piston Ram	φ230
PSCHP003	Schwing piston Ram	φ200
PSCHP004	Schwing piston Ram	φ180
PSCHP005	Schwing seal piston with guide ring	φ200
PSCHP006	Schwing seal piston with guide ring	φ180

### ▷ Putzmeister Piston



Part No.	Name	Description
PPMP001	Putzmeister piston Ram	φ230
PPMP002	Putzmeister piston Ram	φ200
PPMP003	Putzmeister seal piston with guide ring	φ250
PPMP004	Putzmeister seal piston with guide ring	φ230
PPMP005	Putzmeister seal piston with guide ring	φ200
PPMP006	Putzmeister seal piston with guide ring	φ180

### ▷ Sany Piston



Part No.	Name	Description
PSYP001	Sany piston	φ230
PSYP002	Sany piston	φ200
PSYP003	Sany piston	φ195

## ▶ Pipe Bracket



Part No.	Name	Description
PBK4	Pipe bracket	4"
PBK5	Pipe bracket	5"

# コンクリート圧送配管 カタログ

## Wear Plate And Cutting Ring

Part No.	Name	Description
PWPR001	Putzmeister Wear Plate	DN180
PWPR002	Putzmeister Cutting Ring	DN180
PWPR003	Putzmeister Wear Plate	DN200
PWPR004	Putzmeister Cutting Ring	DN200
PWPR005	Putzmeister Wear Plate	DN230
PWPR006	Putzmeister Cutting Ring	DN230
PWPR007	Putzmeister Wear Plate	DN250
PWPR008	Putzmeister Cutting Ring	DN250
PWPR009	Schwing Wear Plate	DN180
PWPR010	Schwing Cutting Ring	DN180
PWPR011	Schwing Wear Plate	DN200
PWPR012	Schwing Cutting Ring	DN200
PWPR013	Schwing Wear Plate	DN230
PWPR014	Schwing Cutting Ring	DN230
PWPR015	Schwing Wear Plate	DN250
PWPR016	Schwing Cutting Ring	DN250
PWPR017	Kyokuto Wear Plate	8"
PWPR018	Kyokuto Cutting Ring	8"
PWPR019	Kyokuto Wear Plate	9"
PWPR020	Kyokuto Cutting Ring	9"
PWPR021	IHI Wear Plate	DN220
PWPR022	IHI Cutting Ring	DN220
PWPR023	IHI Wear Plate	DN225
PWPR024	IHI Cutting Ring	DN225
PWPR025	Mitsubishi Wear Plate	DN205
PWPR026	Mitsubishi Cutting Ring	DN205
PWPR027	CIFA Wear Plate	DN230
PWPR028	CIFA Cutting Ring	DN230
PWPR029	CIFA Wear Plate	DN200
PWPR030	CIFA Cutting Ring	DN200
PWPR031	SERMAC Wear Plate	DN230
PWPR032	SERMAC Cutting Ring	DN230
PWPR033	Niigata Wear Plate	DN210
PWPR034	Niigata Cutting Ring	DN210
PWPR035	Niigata Wear Plate	DN190
PWPR036	Niigata Cutting Ring	DN190

## Conveying Cylinder

Part No.	Name	Description
PCC001	Putzmeister Conveying Cylinder	φ200 × 1400
PCC002	Putzmeister Conveying Cylinder	φ200 × 2100
PCC003	Putzmeister Conveying Cylinder	φ230 × 1400
PCC004	Putzmeister Conveying Cylinder	φ230 × 2100
PCC005	Putzmeister Conveying Cylinder	φ250 × 2500
PCC006	Putzmeister Conveying Cylinder	φ250 × 2100
PCC007	Schwing Conveying Cylinder	φ180 × 1520
PCC008	Schwing Conveying Cylinder	φ180 × 1600
PCC009	Schwing Conveying Cylinder	φ180 × 2000
PCC010	Schwing Conveying Cylinder	φ200 × 1600
PCC011	Schwing Conveying Cylinder	φ200 × 2000
PCC012	Schwing Conveying Cylinder	φ230 × 2000
PCC013	Schwing Conveying Cylinder	φ250 × 2400
PCC014	Kyokuto Conveying Cylinder	φ225 × 1600
PCC015	Kyokuto Conveying Cylinder	φ225 × 1650
PCC016	Kyokuto Conveying Cylinder	φ225 × 1768
PCC017	Kyokuto Conveying Cylinder	φ205 × 1600
PCC018	Kyokuto Conveying Cylinder	φ205 × 1150
PCC019	Kyokuto Conveying Cylinder	φ205 × 1650
PCC020	Kyokuto Conveying Cylinder	φ205 × 1700
PCC021	Kyokuto Conveying Cylinder	φ180 × 1700
PCC022	IHI Conveying Cylinder	φ220 × 1800
PCC023	IHI Conveying Cylinder	φ220 × 1600
PCC024	IHI Conveying Cylinder	φ180 × 1150

## Concrete Box For KCP Trailer Pump

























## Devil Catchers & Blowout Caps

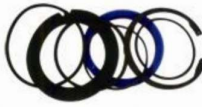

# コンクリート圧送配管 カタログ

## ▶ Putzmeister Spare Parts

			
First elbow	Second elbow	Pipe	
			
Thrust ring DN180	Thrust ring DN200	Thrust ring DN230	Wear sleeve
			
S-Tube	S-Tube	S-Tube	Support flange
			
Plunger cylinder 160-80	Plunger cylinder 160-60	Swinging lever(big mouth)	Swinging lever(small mouth)
			
Outer housing gasket set	Plunger cylinder 160-80 gasket set	Plunger cylinder 160-60 gasket set	
			
outer housing gasket set	Mixer shaft, exterior part	Mixing paddle right-hand	Mixing paddle left-hand

## ▶ Schwing Spare Parts

		
Schwing first ( Elbow )	Schwing Second ( Elbow )	125 ( 150 ) -300 reducer
		
Cover lining	Housing lining DN180	Kidney sealing DN180
		
Rock DN210/180	Bearing bush	Locking cap DN250
		
Slewing lever DN210/180	Connection band DN180 14°	Tapered band DN180/150 90°